

DIN 580 a DIN 582 – šroubovací pevné body

Ceník od 1. 4. 2022

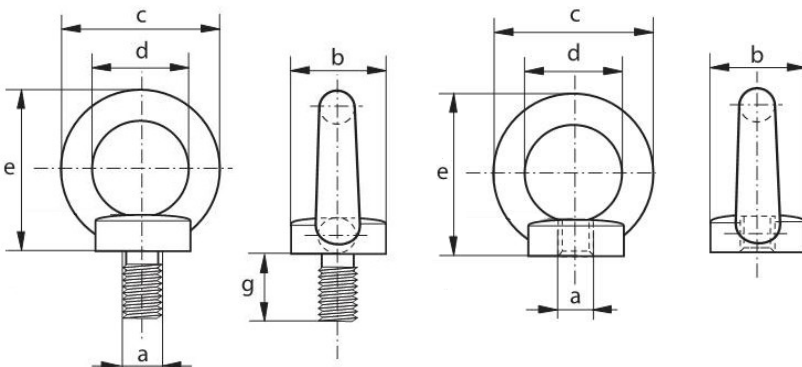

Typ	Závit M	Nosnost (kg)		Rozměry (mm)						Cena DIN 580 (Kč)	Cena DIN 582 (Kč)
		1 bod	2 body, 0° - 45°	a	b	c	d	e	g		
DIN 580/DIN 582 M6	M6	70	50	M6	20	36	20	36	13	24,-	24,-
DIN 580/DIN 582 M8	M8	140	100	M8	20	36	20	36	13	25,-	25,-
DIN 580/DIN 582 M10	M10	230	170	M10	25	45	25	45	17	37,-	37,-
DIN 580/DIN 582 M12	M12	340	240	M12	30	54	30	53	20,5	50,-	50,-
DIN 580/DIN 582 M12	M14	490	350	M14	30	54	30	53	20,5	48,-	48,-
DIN 580/DIN 582 M16	M16	700	500	M16	35	63	35	62	27	76,-	76,-
DIN 580/DIN 582 M16	M18	850	600	M18	35	63	35	62	27	77,-	77,-
DIN 580/DIN 582 M20	M20	1200	860	M20	40	72	40	71	30	104,-	104,-
DIN 580/DIN 582 M22	M22	1400	1000	M22	40	72	40	71	30	113,-	113,-
DIN 580/DIN 582 M24	M24	1800	1290	M24	50	90	50	90	36	226,-	226,-
DIN 580/DIN 582 M27	M27	2100	1500	M27	62	98	54	99	40	355,-	355,-
DIN 580/DIN 582 M30	M30	3200	2300	M30	65	108	60	109	45	475,-	475,-
DIN 580/DIN 582 M36	M36	4600	3300	M36	75	126	70	128	54	798,-	798,-
DIN 580/DIN 582 M42	M42	6300	4500	M42	85	144	80	147	63	1 465,-	1 465,-
DIN 580/DIN 582 M48	M48	8600	6100	M48	100	166	90	168	68	na poptávku	na poptávku
DIN 580/DIN 582 M56	M56	11500	8300	M56	110	184	100	187	78	na poptávku	na poptávku
DIN 580/DIN 582 M64	M64	16000	11000	M64	120	206	110	208	90	na poptávku	na poptávku
DIN 580/DIN 582 M100	M100	38000	27000	M100	190	330	180	330	130	na poptávku	na poptávku

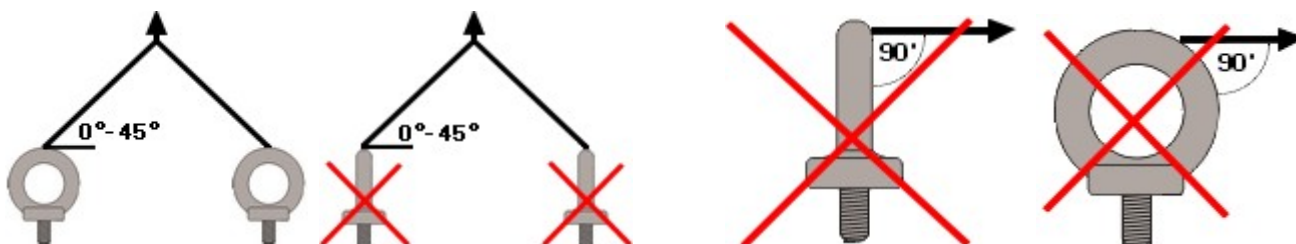

Ceny bez DPH.